

TECHNICAL DATA SHEET

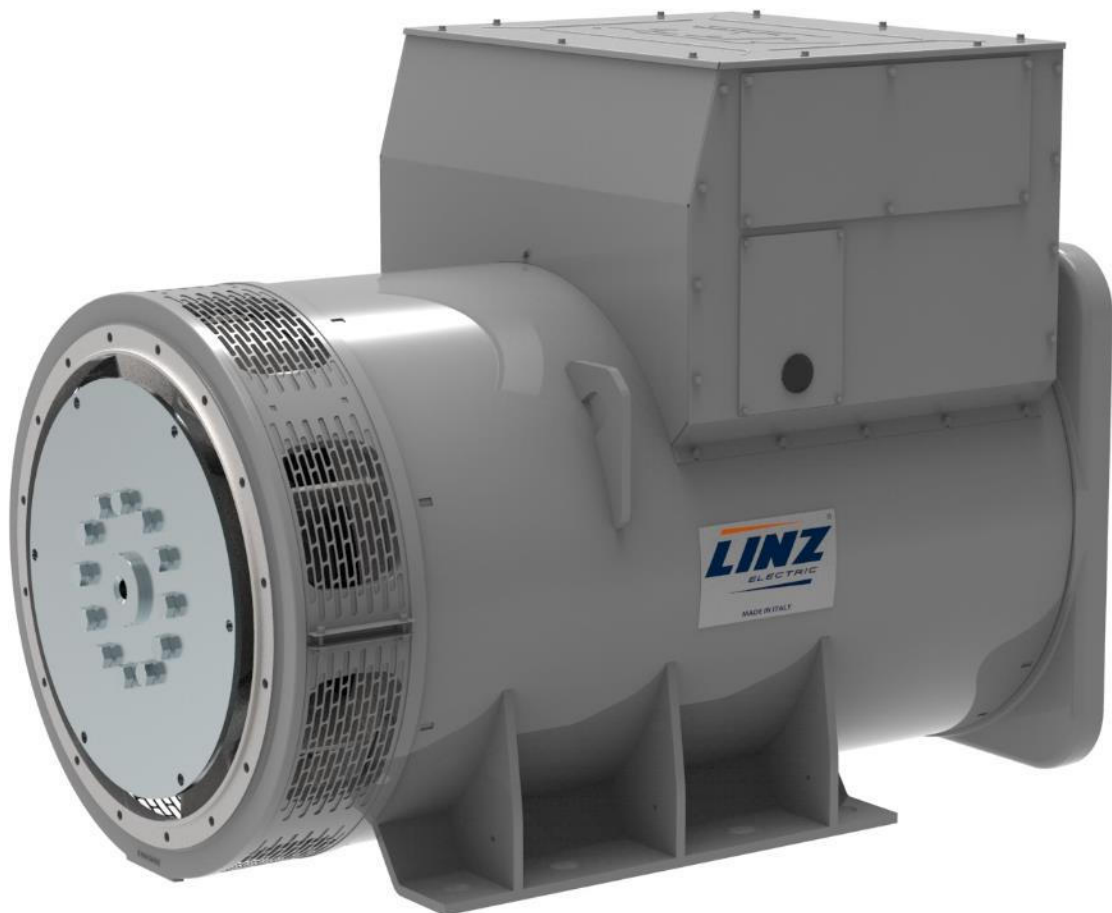

ALTERNATOR PRO40M D/4

Three-Phase brushless synchronous alternator with AVR - 4 poles

PRO40M D/4

COMMON DATA

Rated Power at 50Hz	kVA	1350
Rated Power at 60Hz	kVA	1620
Rated Power Factor		0,8
Nominal Temperature	°C	40
Control System		self-excited
Execution		brushless
Regulation Type		AVR
Insulation Class		H
Protection		IP23
Maximum Over speed	rpm	2250
Overload		110% of rated power for one hour in a cycle of 6 hours
Air Flow Requirement	m ³ /min	94 at 50Hz 113 at 60Hz
R.F.I. Suppression		Standard EN55011

REGULATION DATA

AVR	HVR30
Sensing	three-phase
Voltage Regulation	±1%
Sustained Short Circuit	> 300% of rated current

WINDING DATA

Stator Winding	Double layer with auxiliary winding	
Rotor Winding	with damping cage	
Winding Pitch	2/3	
Number of Leads of Stator	6*	
Stator Winding Resistance	Ω	0,0056 at 20°C
Rotor Winding Resistance	Ω	0,876 at 20°C
Exciter Stator Resistance	Ω	13,3 at 20°C
Exciter Rotor Resistance	Ω	0,051 at 20°C
THD at full load	<3%	
THD at no load	<3%	
Excitation at no load	Adc	0,59
Excitation at full load	Adc	2,78

Note (*): 230/400V - 460/800V 50Hz
277/480V - 554/960V 60Hz

STANDARD

References	EN60034-1 ISO8528-3 EN55011
------------	-----------------------------

PRO40M D/4

ELECTRICAL DATA

Frequency		50Hz - 1500rpm				60Hz - 1800rpm			
Voltage Series Star	V	380/220	400/230	415/240	440/254	415/240	440/254	460/266	480/277
Rated Power in Class H (125°C/40°C)	kVA	1350	1350	1350	1300	1480	1550	1620	1620
	kW	1080	1080	1080	1040	1184	1240	1296	1296
Rated Power in Class F (105°C/40°C)	kVA	1280	1280	1280	1280	1400	1460	1540	1540
	kW	1024	1024	1024	1024	1120	1168	1232	1232
Rated Power Standby (150°C/40°C)	kVA	1450	1450	1450	1450	1600	1660	1750	1750
	kW	1160	1160	1160	1160	1280	1328	1400	1400
Rated Power Standby (163°C/27°C)	kVA	1500	1500	1500	1500	1650	1700	1800	1800
	kW	1200	1200	1200	1200	1320	1360	1440	1440

EFFICIENCY IN CL. H

4/4	95,8%							96,5%
3/4	96,1%							96,7%
2/4	95,8%							96,5%
1/4	92,5%							93,7%

REACTANCES AND TIME CONSTANTS

pcc		0,32							
X _d - dir. axis synchronous		303%	274%	254%	218%	334%	312%	298%	274%
X' _d - dir. axis transient		34,9%	31,5%	29,3%	25,1%	38,5%	35,9%	34,3%	31,5%
X'' _d - dir. axis subtransient		14,8%	13,4%	12,4%	10,7%	16,4%	15,3%	14,6%	13,4%
X _q - quad. axis reactance		161%	145%	135%	115%	177%	165%	158%	145%
T' _{do} - O.C. field time constant						1989ms			
T' _d - Transient time constant						229ms			
T'' _d - Sub-transient time constant						22ms			

MECHANICAL DATA

Bearing non drive end				6318-2RS1-C3
Bearing drive end (B3/B14 form)				6324-C3
Weight of generator	in B2	kg		2635
	in B3/B14	kg		2690

PRO40M D/4

MOMENT OF INERZIA

SAE 14	kg·m ²	24,454
SAE 18	kg·m ²	24,846
SAE 21	kg·m ²	25,496
B3/B14	kg·m ²	23,429

DERATING CURVES

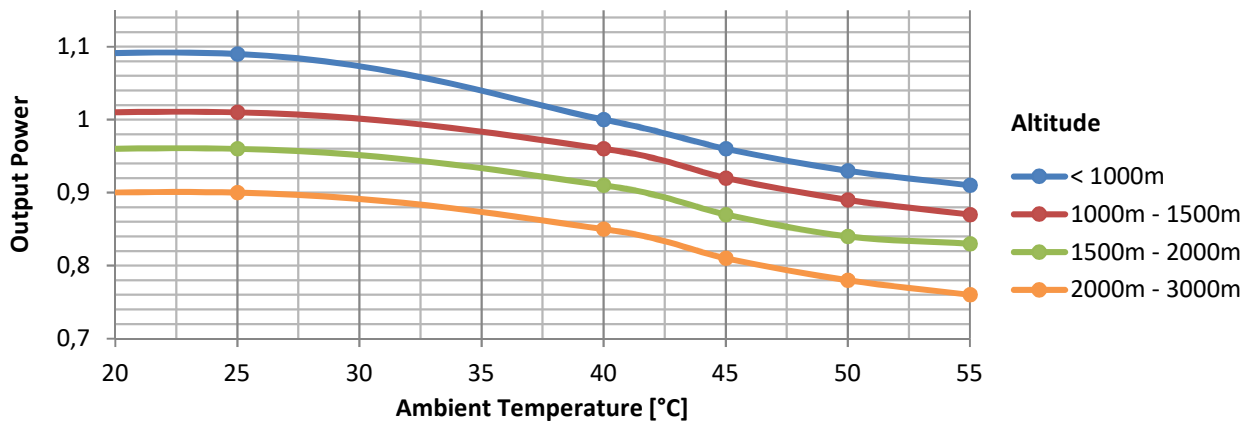

WIRING DIAGRAM

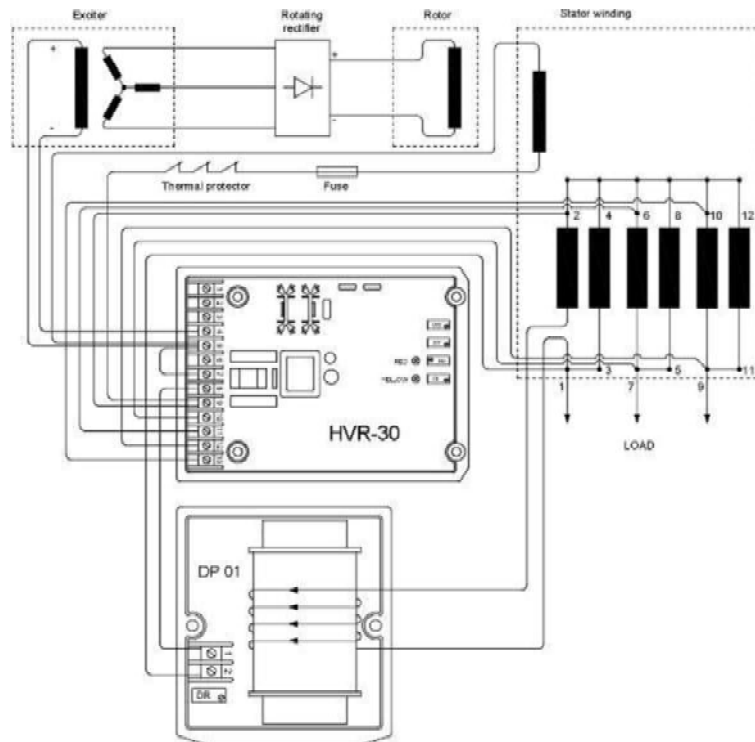

PRO40M D/4

TRANSIENT VOLTAGE VARIATION 50Hz

Transient Voltage Variation @ 50Hz

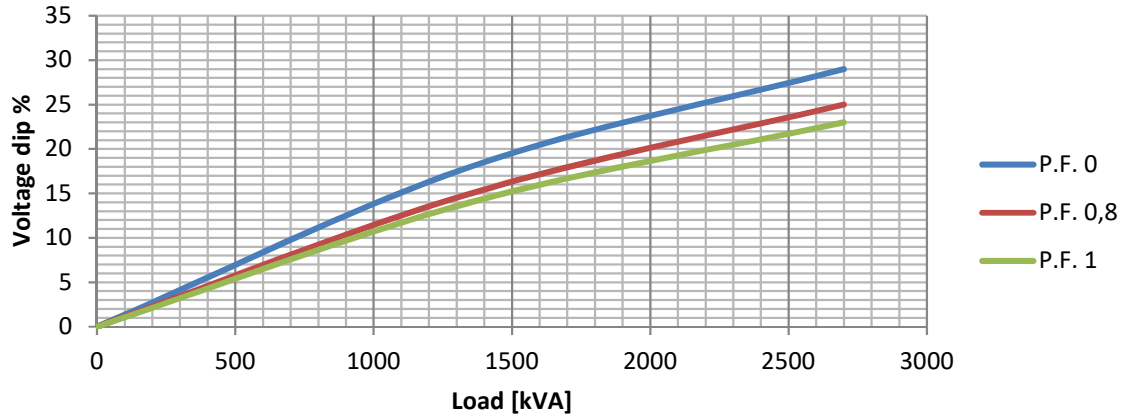

TRANSIENT VOLTAGE VARIATION 60Hz

Transient Voltage Variation @ 60Hz

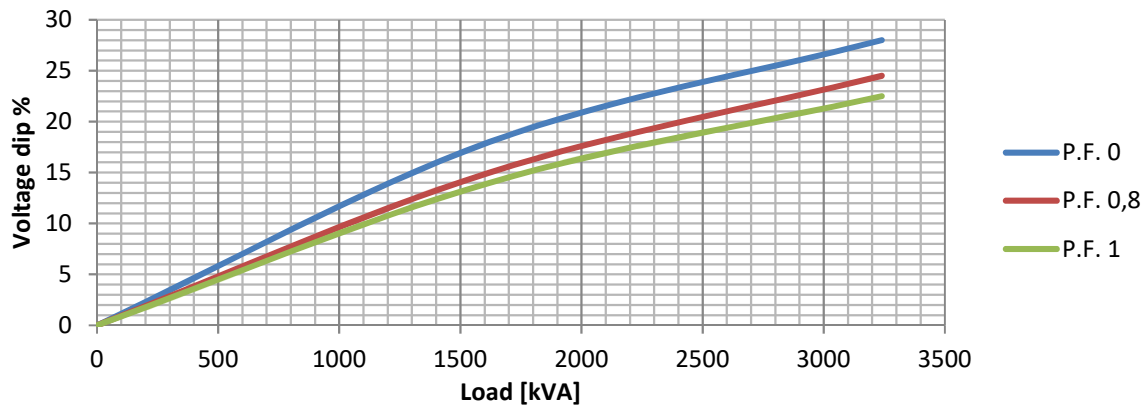

PRO40M D/4

EFFICIENCY 50Hz

Efficiency Curves @ 50Hz

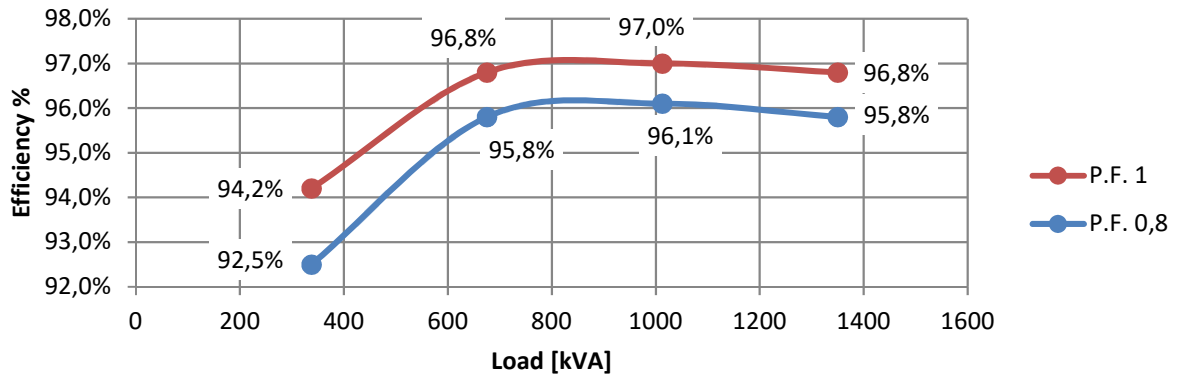

EFFICIENCY 60Hz

Efficiency Curves @ 60Hz

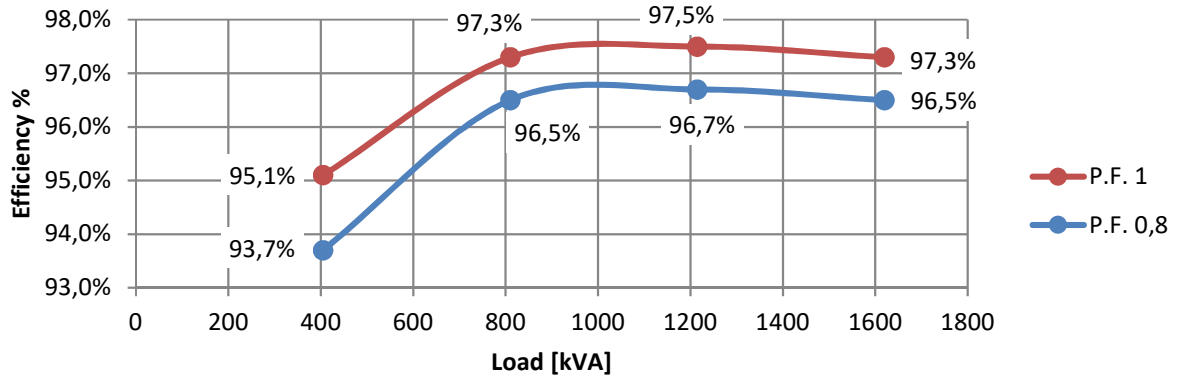

PRO40M D/4

FORMA - FORM B3/B14

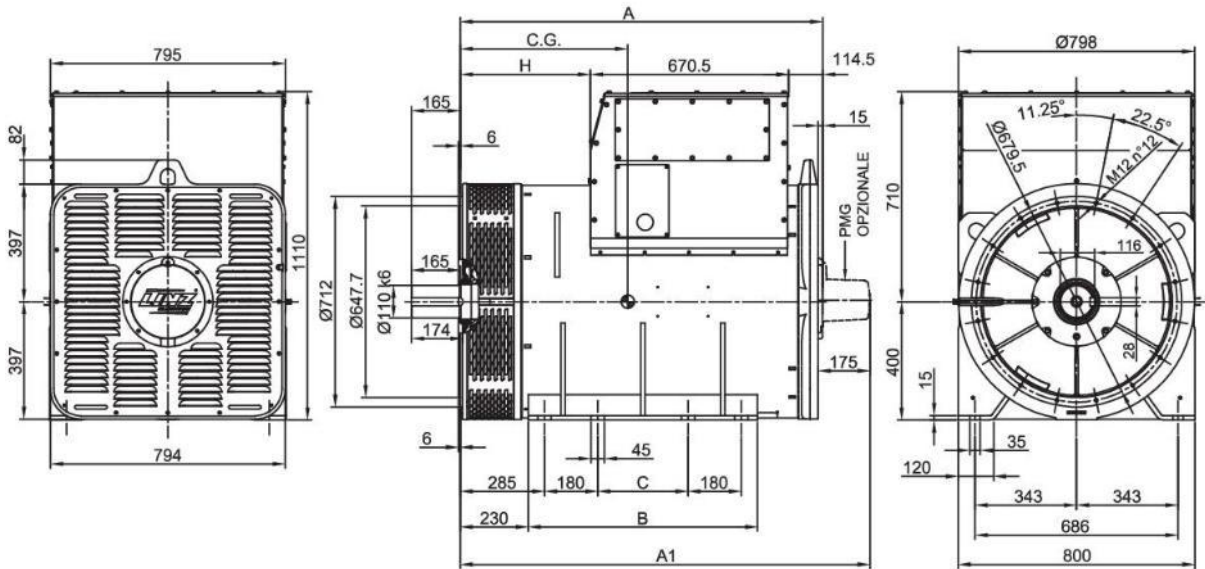

FORMA - FORM SAE

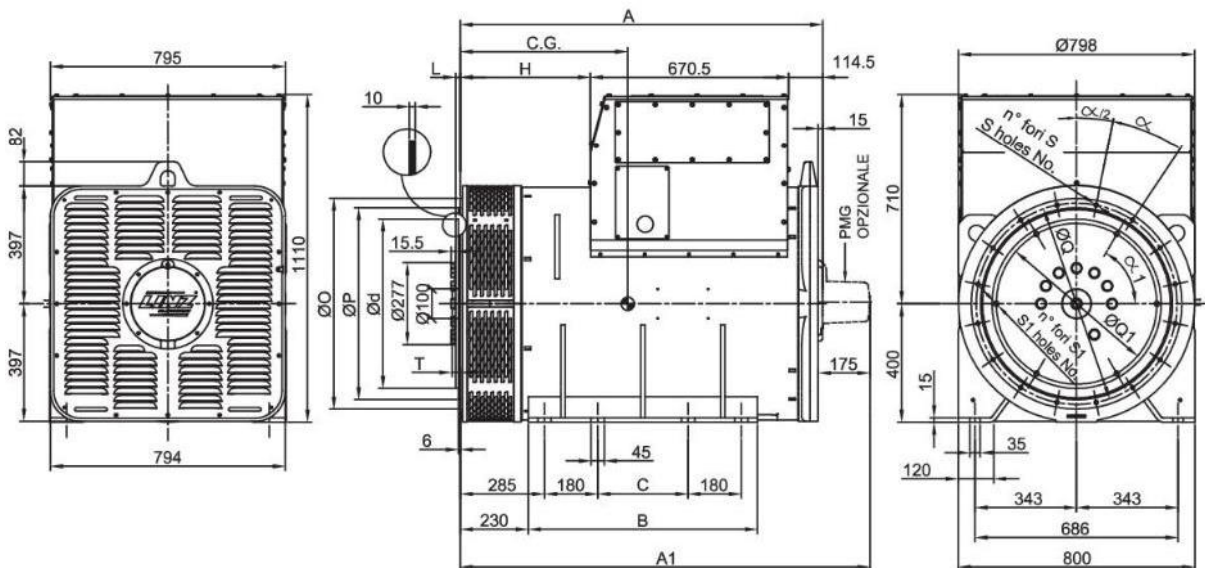

FORMA - FORM	A	H	A1	B	C	
B3/B14	PRO40 S	1225	440	1385	775	305
	PRO40 M	1420	635	1580	775	305
	PRO40 L	1625	840	1785	965	495
SAE	PRO40 S	1225	440	1385	775	305
	PRO40 M	1420	635	1580	775	305
	PRO40 L	1625	840	1785	965	495

TIPO - TYPE	C.G.
PRO40S A/4	597
PRO40S B/4	597
PRO40M C/4	648
PRO40M D/4	693
PRO40L E/4	795

SAE N.	FLANGIE - FLANGES - BRIDAS					
	Ø O	Ø P	Ø Q	n. fori holes No.	S	α
OO	883	787.4	850.9	16	14	22.5°
O	710	647.7	679.5	16	14	22.5°

SAE N.	GIUNTI A DISCO - COUPLING DISCS - JUNTAS A DISCOS						
	L	Ø d	Ø Q1	n. fori holes No.	S1	α1	T
14	25.4	466.72	438.15	8	14	45°	2
18	15.7	571.5	542.92	6	17	60°	12
21	0	673.1	641.35	12	17	30°	28